



**NHD**  
NATIONAL  
HISTORY DAY



---

# Contest Rule Book

# Contest Rule Book

National History Day (NHD) programs are open to all students and teachers without regard to race, sex, religion, physical abilities, economic status, or sexual orientation. NHD does not discriminate against, or limit participation by, physically challenged students. NHD staff and affiliate coordinators strive to accommodate students with special needs.

**This rule book takes effect at the beginning of the 2014-15 academic year and supersedes all previous versions.**

# Table Of Contents

<b>I. What is National History Day?</b>	
A. About the Contest.....	4
B. Definitions.....	5
<b>II. Program Overview</b>	
A. Theme.....	10
B. Topic.....	10
C. Rewards for Participation.....	10
D. Divisions.....	11
E. Contest Categories.....	11
F. Important Notices for Contestants.....	12
G. Program Materials.....	12
<b>III. Rules For All Categories</b>	
A. General Rules for All Categories.....	14
B. Required Written Material for All Entries.....	16
C. Contest Participation.....	19
<b>IV. Individual Category Rules</b>	
A. Paper.....	20
B. Exhibit.....	23
C. Performance.....	26
D. Documentary.....	28
E. Website.....	31
<b>V. How Will Your Entry Be Judged?</b>	
A. Benefits of the Evaluation Process.....	36
B. Who are the Judges?.....	36
C. How Does the Evaluation Process Work?.....	36
D. Consensus Judging.....	37
E. The Subjective Nature of Judging.....	37
F. The Decision of the Judges is Final.....	37
G. Evaluation Criteria.....	38
i. Historical Quality.....	38
ii. Relation to Theme.....	38
iii. Clarity of Presentation.....	39
H. Rule Compliance.....	39
I. Sample Judges' Evaluations.....	40
<b>VI. Rules Verification Sheets</b>	42
<b>For Further Information</b>	43

# **I.** What is National History Day?

NHD, a non-profit education organization based in College Park, Maryland, offers year-long academic programs that engage over half a million middle- and high-school students around the world annually in conducting and presenting original research on historical topics. Since 1974, NHD has continuously improved history education by providing professional development opportunities and curriculum materials for educators. It provides the organizational structure for students like you to enter contests at the local and affiliate levels, with top students advancing to the national competition at the University of Maryland at College Park.

## ABOUT THE CONTEST

Through your participation in the contest, you will experience important benefits beyond learning about interesting issues, ideas, people, and events of your choosing. You will hone your expressive abilities as you demonstrate command of your topic and present your work in one of the competition's formats: paper, exhibit, performance, documentary, or website. At the local and affiliate competitions, you have the opportunity to meet students from other schools, exchange ideas, and demonstrate the results of your work. Your success in researching and producing an NHD entry may even take you to the National Contest.

### PLEASE READ THIS!

Before you begin work on your entry, you, your teacher, and your parents should read this *Contest Rule Book* carefully. It contains rules that you must follow to compete in all levels of the NHD competition. More information about topics, sources, and deadlines is available from your regional and affiliate NHD coordinators. Find your affiliate coordinator at <http://www.nhd.org/Coordinators.htm>. Always contact your regional or affiliate coordinator to learn whether any rules have been revised. The most up-to-date rules are available on the NHD website at <http://www.nhd.org/GettingStarted.htm>.

## DEFINITIONS

**AFFILIATE:** An NHD program organized by a coordinator and recognized as such by the national office; usually designated by a geographical name (e.g., Iowa, Guam, South Korea, etc.). In many affiliates, students qualify for the affiliate contest by placing at a regional contest, while other affiliate contests have open enrollment. Please check with your affiliate coordinator at <http://www.nhd.org/Coordinators.htm> to see what model your affiliate follows.

**REGION:** An NHD program, usually one of several within an affiliate, organized by a regional coordinator and recognized as such by the affiliate office; usually designated by a geographical name (e.g., western Pennsylvania) or a number (e.g., Texas region 1) and often the first level of competition. Consult your affiliate's website for details on the regional contest in your geographical area.

**CONTEST YEAR:** The time immediately following the National Contest awards ceremony through the next year's National Contest awards ceremony. You may begin working on a project for competition after the conclusion of the previous contest year in June.

**ENTRY:** One project entered once within a contest year. You may only enter one regional and/or one affiliate contest with one project. Multiple entries (in any form), as well as reusing research from a previous year's project, will result in disqualification from the contest.



**FAIR USE:** The use of copyrighted material for your project falls under the Fair Use doctrine, which identifies educational use for non-commercial purposes as acceptable with certain limitations. You should not place your project in a non-academic public setting, such as a commercial Internet site, without obtaining permission from the copyright owner. Read more here: <http://www.copyright.gov/fls/fl102.html>.

**PLAGIARISM:** Presenting the work or ideas of others in ways that give the impression that they are your own (copying information word-for-word without using both quotations and citations, paraphrasing an author’s ideas without proper attribution, or using visuals or music without giving proper credit). Plagiarism in any form will result in disqualification from the contest.

**RULE INFRACTION:** A violation of any of the rules stated in this *Contest Rule Book*. Judges will take any rule infractions into consideration in their final rankings. Failure to comply with the rules will count against your entry but will only result in disqualification as delineated below. Any rule infractions should be corrected before a winning entry competes in the next level of competition.

**DISQUALIFICATION:** Removal of an entry from competition. A project may be disqualified from the contest on three grounds:

1. Plagiarizing all or part of the NHD project. Please note that failing to give proper credit is plagiarism.
2. Reusing, individually or as a group, a project (or research from a project) from a previous year, or entering a project in multiple contests or entry categories within a contest year.
3. Tampering with any part of the project of another student.



**HISTORICAL CONTEXT:** The appropriate settings in which to understand your subject's time period. Settings might include relevant physical, economic, intellectual, and/or socio-cultural characteristics of the place and time.

**HISTORICAL PERSPECTIVE:** Understanding a topic's development over time and its influence.

**PRIMARY SOURCE:** Something that was written or produced in the time period you are investigating (letters, speeches, diaries, newspaper articles from the time, oral history interviews of people from the time, documents, photographs, artifacts, and anything else that provides firsthand accounts about a person or event). This definition also applies to primary sources found on the Internet. A letter written by President Lincoln in 1862 is a primary source for a student researching the Civil War era. An article about the Vietnam War published in 2001 and not written by an eyewitness or participant about his or her experience is **not** a primary source. An interview with an expert (such as a professor of Vietnamese history) is **not** a primary source UNLESS that expert actually lived through and has firsthand knowledge of the events being described. Primary materials such as quotes from historical figures or photographs of historical events, when found in secondary sources, can be used effectively in NHD projects; however, these are not considered primary sources. Figure 1 provides a comparison of primary material found in a textbook (secondary source) and the original document.

***NOTE:** Check out the "Conducting Research" page in the Contest section on the NHD website at <http://www.nhd.org> for additional help on primary sources.*

**SECONDARY SOURCE:** A source by an author who was **not** an eyewitness or a participant in the historical event or period. Secondary sources are interpretations of primary sources, research, and study. Secondary sources provide context for a historical event. For example, high school history textbooks and history books about a particular topic are secondary sources; so are biographies and reference sources such as encyclopedias. This definition also applies to descriptive articles or information found on the Internet.



**FIGURE 1 | COMPARISON OF ORIGINAL PRIMARY MATERIAL WITH SECONDARY SOURCE EXCERPT**

Abigail Adams wrote a letter to her husband, John, in 1776. Below is an excerpt of the letter included in a textbook and a copy of the original document accessed on the Internet. The excerpt is a secondary source because it only includes part of the letter and thus, does not provide full context. The original is a primary source. Citations are provided for both as well as for the actual document.



**Secondary Source – Textbook:**

Adams, Abigail. "Letter from Abigail Adams to John Adams, 31 March - 5 April 1776." *The American Pageant: A History of the American People*, by David M. Kennedy, Lizabeth Cohen, and Thomas Bailey, 153. Boston: Wadsworth, 2010.



**Primary Source – Website (as shown here):**

Adams, Abigail. "Letter from Abigail Adams to John Adams, 31 March - 5 April 1776." Adams Family Papers: An Electronic Archive, Massachusetts Historical Society. Accessed April 29, 2014.  
<http://www.masshist.org/digitaladams/archive/doc?id=L17760331aa>.

**Primary Source – The actual letter:**

Adams, Abigail. "Letter from Abigail Adams to John Adams, 31 March - 5 April 1776." Adams Family Papers. Massachusetts Historical Society, Boston, MA.





unlettered.  
disenf

yet 

FISHWI  
RIGHTS

Declaratio  
of Man

## II.

# Program Overview

### THEME

Each year NHD selects a theme for the contest. Although you may select a topic on any aspect of local, regional, national, or world history, your project's research and conclusions must relate clearly to the annual theme. Be careful to limit the scope of your topic to focus on an issue that can be explained and interpreted within the category limits of size and time.

### TOPIC

Effective NHD entries not only describe an event or a development, but they also analyze and place it in its historical context. To help you draw conclusions about your topic's significance in history, ask yourself the following questions:

- How was my topic significant in history in relation to the NHD theme?
- How did my topic develop over time?
- How did my topic influence history?
- How did the events and atmosphere (social, economic, political, and cultural aspects) of my topic's time period influence my topic in history?
- Why is my topic important?

### REWARDS FOR PARTICIPATION

The most important rewards are the skills and new knowledge that you will acquire as you move through the NHD program. At each level of competition, outstanding achievement also may be recognized through certificates, medals, trophies, scholarships, or monetary awards. A number of special prizes may be given at the regional, affiliate, or national level.

## DIVISIONS

The NHD competition has two divisions based on school grade.

- Junior Division — grades 6, 7, and 8
- Senior Division — grades 9, 10, 11, and 12

Entries in each division are judged separately at all levels of competition.

**NOTE:** *Some affiliates sponsor participation in 4th and 5th grades. Check with your affiliate coordinator for more information. You can find your coordinator through the NHD website, <http://www.nhd.org/Coordinators.htm>.*

**NOTE:** *Students in non-graded schools must check with the NHD office to determine in which division they should register for the competition.*

## CONTEST CATEGORIES

You may enter one of nine categories:

- paper (individual only)
- individual exhibit
- group exhibit
- individual performance
- group performance
- individual documentary
- group documentary
- individual website
- group website

Each category in each division is judged separately. Groups may include two to five students. Group participants do not have to be in the same grade to compete together, but they must be in the same division.

**NOTE:** *Choose a category in which you can make the best use of your special abilities, talents, and interests. Be careful to choose the most suitable category in which to present your research and conclusions and take into consideration the availability of equipment and resources.*

## IMPORTANT NOTICES FOR CONTESTANTS

All contests are held in public areas. You are solely responsible for the security and safety of your own equipment and artifacts. NHD program officials and sponsors will not be responsible for the loss of, or damage to, exhibits, props, equipment, or personal belongings.

## PROGRAM MATERIALS

Each year program materials such as topic suggestions, sample entries, videos, and category tips are available on the NHD website at <http://www.nhd.org>. These materials are provided to help teachers and students participate in the NHD program and may be duplicated for classroom use. Additional materials may be purchased from the NHD online shop. For further information or to order materials, contact your regional or affiliate coordinator or the NHD office.

NHD also conducts webinars throughout the year. You are encouraged to take advantage of these resources.





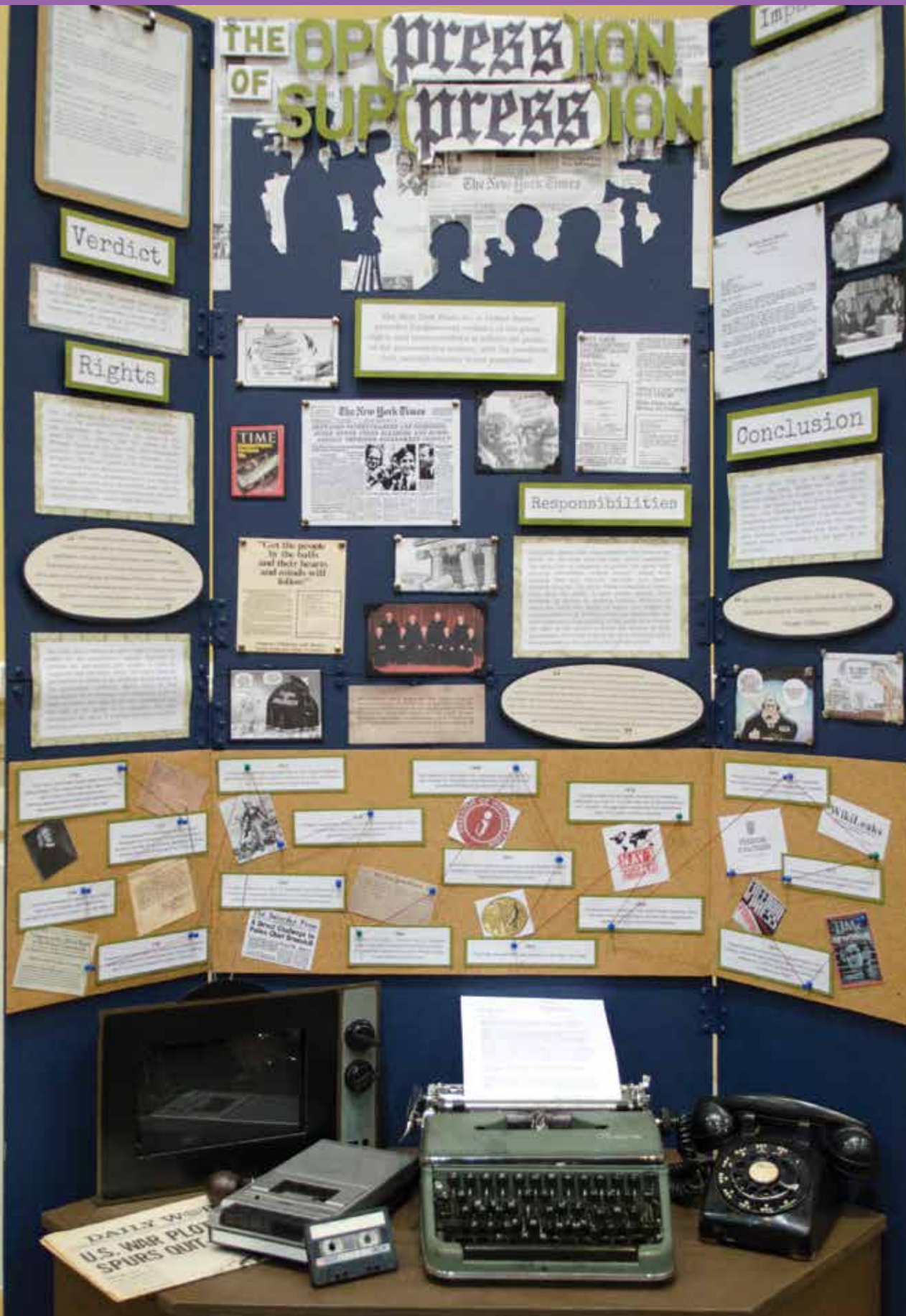

# III.

# Rules for All Categories

## GENERAL RULES FOR ALL CATEGORIES

### **Rule 1 | Annual Theme**

Your entry must relate clearly to the annual theme and explain your topic's significance in history.

### **Rule 2 | Contest Participation**

You may participate in the research, preparation, and presentation of only one entry each contest year. You may share research with up to four other students who are fellow participants in your group entry. You may not create a common pool of research from which several entries are developed.

### **Rule 3 | Individual or Group Entries**

A paper, individual exhibit, individual performance, individual website, or individual documentary must be the work of only one student. A group exhibit, group performance, group website, or group documentary must be the work of two to five students. All students in a group entry must be involved in the research and interpretation of the group's topic. Once a group project enters a competition (regional or affiliate), additional students may not be added or replaced at that or subsequent competitions within a contest year.

### **Rule 4 | Development Requirements**

Entries submitted for competition must be original and have been researched and developed in the current contest year. Revising or reusing an entry from a previous year—whether it is yours or another student's—will result in disqualification. The contest year begins each June, following the National Contest.

**Rule 5 | Construction of Entry**

You are responsible for the research, design, and creation of your entry. You may receive help and advice from teachers and parents on the mechanical aspects of creating your entry, such as typing your paper and other written materials. You may seek guidance from your teachers as you research and analyze your material, but your conclusions must be your own. You may have reasonable help preparing your project.

Examples of reasonable help include:

- a teacher instructs you in how to use an editing software program
- a parent uses a cutting tool to cut the exhibit board or performance prop that you designed
- a teacher offers editing suggestions on your historical paper
- a parent assists in sewing costumes that you have designed
- a teacher shows you or your group how to build an NHD website
- you have photographs commercially developed

***NOTE:** Objects created by others specifically for use in your entry violate this rule. Examples include a parent editing a documentary or an artist drawing the backdrop for your exhibit or performance. You may receive reasonable help in carrying and placing props and exhibits.*

**Rule 6 | Tampering with Another NHD Entry**

You may not tamper with, deface, or alter another student's or group's entry. Doing so will result in your project's disqualification.

**Rule 7 | Contest Day Setup**

You are responsible for setting up your own exhibit, equipment, or props at the contest. You may have reasonable help carrying them, but setup must be completed by you (and/or your group members).

**Rule 8 | Supplying Equipment**

You are responsible for supplying all props and equipment at each level of competition. All entries should be constructed with transportation, setup time, size, and weight in mind (e.g., foam board versus solid oak for an exhibit, folding table versus antique desk for a performance, etc.). You must provide your own equipment, including computers and software, unless the contest coordinator has specified that certain equipment



will be provided at the contest venue. Projection screens for documentaries and performances may be provided, if requested. Check with your contest coordinator about available resources at all contest levels. Be prepared.

### **Rule 9 | Discussion with Judges**

You should be prepared to answer judges' questions about the content and development of your entry and to explain the design, research, and creation of your entry. Judges need to know that your entry is the result of your own work. However, you may not give a formal, prepared introduction, narration, or conclusion. Let the judges' questions guide the interview. Ultimately, your entry should be able to stand on its own without any additional comments from you.

### **Rule 10 | Costumes**

You are not permitted to wear costumes that are related to the focus of your entry during judging, except in the performance category.

### **Rule 11 | Prohibited Materials**

Items potentially dangerous in any way—such as weapons, firearms, animals, organisms, plants, etc.—are strictly prohibited. Such items will be confiscated by security personnel or contest officials. Replicas of such items that are obviously not real are permissible. Contact your teacher and contest coordinator to confirm guidelines before bringing the replica to a contest.

### **Rule 12 | Title**

Your entry must have a title that is clearly visible on all written materials.

## **REQUIRED WRITTEN MATERIAL FOR ALL ENTRIES**

### **Rule 13 | Written Material**

Your entry must include the following written material in the order presented below:

1. A title page as described in Rule 14;
2. A process paper as described in Rule 15 (process papers are not required for paper entries);
3. An annotated bibliography as described in Rule 16.

These materials must be typed or neatly printed on plain white paper, and stapled together in the top left corner. **Do not enclose them in a cover or binder.**

**Exhibit, performance and documentary categories** – you must provide three copies of these materials, bringing along an extra set for your own reference.

**Website category** – you must include these required materials within the site.

**Paper category** – You must include the title page and annotated bibliography with your paper.

**Rule 14 | Title Page**

A title page is required as the first page of written material in every category. Your title page must include **only** the title of your entry, your name(s), the contest division and category in which you are entered, and applicable word counts. Please see Figure 2 for examples of required elements for the paper, exhibit, performance, and documentary categories. Details of requirements for a website’s home page can be found in Rule E3.

***NOTE:** The title page **must not** include any other information (pictures, graphics, borders, school name, or grade) except for that described in this rule.*

**FIGURE 2 | SAMPLE TITLE PAGES**

Title Name Junior Division Historical Paper Paper Length: 2,234 words	Title Name Junior Division Group Exhibit Student-composed Words: 489 Process Paper: 410 words	Title Name Senior Division Individual Performance Process Paper: 425 words	Title Name Senior Division Individual Documentary Process Paper: 410 words
---	--	--	--

### Rule 15 | Process Paper

All categories, except historical paper, must include a process paper with the entry. It must describe in 500 or fewer words how you conducted your research and created your entry. The process paper must include four sections that explain:

1. how you chose your topic;
2. how you conducted your research;
3. how you selected your presentation category and created your project; and
4. how your project relates to the NHD theme.

You can view sample process papers at <http://www.nhd.org/CreatingEntry.htm>.

### Rule 16 | Annotated Bibliography

An annotated bibliography is required for all categories. List only those sources that contributed to the development of your entry, i.e., sources that provided usable information or new perspectives in preparing your entry. Sources of visual and audio materials and oral interviews must be included. Bundle photos or other materials from the same collection in a single citation. The annotations for each source must explain how you used the source and how it helped you understand your topic. Your annotated bibliography is not included in the word count.

For example:

Bates, Daisy. *The Long Shadow of Little Rock*. New York: David McKay Co. Inc., 1962.

Daisy Bates was the president of the Arkansas NAACP and the one who met and listened to the students each day. This firsthand account was very important to my paper because it made me more aware of the feelings of the people involved.

**NOTE:** *Oral history transcripts, correspondence between you and experts, questionnaires, and other primary or secondary materials used as sources for your entry should be cited in your bibliography but not included as attachments to your bibliography.*

### Rule 17 | Separation of Primary and Secondary Sources

You are required to separate your bibliography into two sections: one for primary sources and one for secondary sources.

**NOTE:** Some sources may be considered as either primary or secondary. Use your annotations to explain your reasoning for classifying any sources that are not clearly primary or secondary. Listing a source under both primary and secondary is inappropriate.

### **Rule 18 | Style Guides**

Style for citations and bibliographic references must follow the principles in a recent edition of one of the following style guides.

1. Kate L. Turabian, *A Manual for Writers of Research Papers, Theses and Dissertations: Chicago Style for Students and Researchers*
2. Joseph Gibaldi, *MLA Handbook for Writers of Research Papers*

Regardless of which manual you use, the style must be consistent throughout all written material.

### **Rule 19 | Plagiarism**

You must acknowledge in your annotated bibliography all sources used in your entry. Failure to credit sources is plagiarism and will result in disqualification.

## **CONTEST PARTICIPATION**

### **Rule 20 | Entry Procedure**

At each contest level you must register online or by submitting paper entry forms (check with your contest coordinator for the required format), meet specific deadlines, and follow any procedures established by that contest's coordinator. You are responsible for knowing and meeting the deadlines.

### **Rule 21 | Entries to National Contest**

Each affiliate is limited to two entries per contest category in the National Contest. Ties at affiliate contests must be resolved at the affiliate level.

### **Rule 22 | National Contest Attendance**

Individual students and groups must be present for an entry to be judged at the National Contest. All members of a group entry must register for the National Contest.

## IV.

# Individual Category Rules

## A. PAPER

A paper is the traditional form of presenting historical research. Various types of creative writing (e.g., fictional diaries, poems, etc.) are permitted, but must conform to all general and category rules. Your paper should be grammatically correct and well written.

**Part III, Rules for all Categories (except for Rule 15), applies to papers.**

A1	<b>Length Requirements</b>	<ul style="list-style-type: none"><li>• Historical papers must be between 1,500 and 2,500 words.</li><li>• Each word or number in the text of the paper counts as one word. This includes student-composed text as well as quotes from primary or secondary sources.</li><li>• The 2,500-word limit does not apply to notes, the annotated bibliography, illustration captions, and appendix material. Appendix material must be referenced in the text of the paper. Extensive supplemental materials are inappropriate. Use of appendices should be very limited and may include photographs, maps, charts, and/or graphs only.</li></ul> <p><i><b>NOTE:</b> Oral history transcripts, correspondence between you and experts, questionnaires, and other primary or secondary materials used as sources for your paper should be cited in your bibliography but not included as attachments/appendices to your paper.</i></p>
A2	<b>Citations</b>	<ul style="list-style-type: none"><li>• Citations—footnotes, endnotes, or internal documentation—are required.</li><li>• Citations are used to credit the sources of specific ideas as well as direct quotations.</li><li>• Refer to Part III, Rule 18, for citation styles. Please note that an extensively annotated footnote should not be used to get around the word limit.</li></ul>

A3	<b>Preparation Requirements</b>	<ul style="list-style-type: none"> <li>• Papers must be typed or computer printed on plain, white 8.5 x 11-inch paper with 1-inch margins on all sides.</li> <li>• Pages must be numbered consecutively and double-spaced with writing on one side and in 12-point font.</li> <li>• Papers must be stapled in the top left corner and <b>should not be enclosed in a cover or binder</b>. Refer to Part III, Rule 14, for title page requirements.</li> <li>• See Figure 3 for an example of a properly formatted page.</li> </ul>
A4	<b>Number of Copies</b>	<ul style="list-style-type: none"> <li>• Four copies of the paper and annotated bibliography must be submitted prior to the contest, via the appropriate registration process, by the deadline established for the contest.</li> <li>• Winning papers sometimes are published by contest officials; you must be prepared to give permission for such publication.</li> <li>• You must bring a copy of your paper and annotated bibliography to the contest for your use.</li> </ul>





FIGURE 3 | SAMPLE PAPER PAGE

4

The second major issue debated at the Yalta Conference was the destiny of the Polish state. The Polish nation fluctuated between existence and partition throughout European history. After World War I, the Treaty of Versailles created the modern Polish state. In 1939, Germany demanded land and economic concessions from the nation, and the Polish government refused to concede to these demands. On March 31, 1939, Poland signed an agreement with Great Britain and France in which these nations promised to provide aid to Poland if attacked by Germany. On September 1, 1939, Germany invaded Poland with two army groups while stationing the German navy to prevent a British attack from the sea.<sup>1</sup> Warsaw was surrounded by September 17, and after heavy bombing raids, surrendered ten days later.<sup>2</sup>

Poland was overrun quickly, “with a speed that astonished the rest of the world.”<sup>3</sup> The Polish government and military leaders fled to France, and later to London. Poland remained occupied for most of the war. Soviet troops finally took control of Warsaw in January 1945. Poland was largely “written off at Yalta,” despite the fact that it fought with the Allied powers in exile.<sup>4</sup>

The representatives at the Yalta Conference made the following decision regarding the Polish state:

A new situation has been created in Poland as a result of her complete liberation by the Red Army. This calls for the establishment of a Polish Provisional Government...which is now functioning in Poland should therefore be reorganized on a broader democratic basis with the inclusion of democratic leaders from Poland itself and from Poles abroad. This new Government should then be called the Polish Provisional Government of National Unity.<sup>5</sup>

As World War II began to shift in favor of the Allies, it became evident that several questions

<sup>1</sup> James L. Stokesbury, *A Short History of World War II* (New York: Harper, 1980), 69-71.

<sup>2</sup> John Keegan, *The Second World War* (New York: Penguin, 1989), 46.

<sup>3</sup> Stokesbury, *A Short History of World War II*, 75.

<sup>4</sup> Keegan, *The Second World War*, 542.

<sup>5</sup> “The Yalta Agreement,” The Avalon Project, Yale Law School, last modified 2008, accessed January 3, 2014, <http://avalon.law.yale.edu/wwii/yalta.asp>.



## B. EXHIBIT

An exhibit is a visual representation of your research and interpretation of your topic's significance in history. The analysis and interpretation of your topic must be clear and evident to the viewer. Labels and captions should be used creatively with visual images and objects to enhance the message of your exhibit.

### Part III, Rules for all Categories, applies to exhibits.

B1	<p><b>Size Requirements</b></p>	<ul style="list-style-type: none"> <li>• The overall size of your exhibit when displayed for judging must be no larger than 40 inches wide, 30 inches deep, and 6 feet high.</li> <li>• Measurement of the exhibit does not include the table on which it rests; however, it does include any stand that you create and any table drapes.</li> <li>• Circular or rotating exhibits or those meant to be viewed from all sides must be no more than 30 inches in diameter. See Figure 4 for illustration.</li> </ul>
B2	<p><b>Word Limit</b></p>	<ul style="list-style-type: none"> <li>• A 500-word limit applies to all student-composed text that appears on, or as part of, an exhibit entry.</li> <li>• This includes the text that you write for titles, subtitles, captions, graphs, timelines, media devices, or supplemental materials (e.g., photo albums, scrapbooks, etc.) where you use your own words.</li> <li>• Brief factual credits of the sources of illustrations or quotations included on the exhibit do not count toward the 500-word limit. A date (January 1, 1903) counts as one word. See Figure 5 for additional explanation.</li> </ul> <p><i><b>NOTE:</b> Be careful that your message is clear on the exhibit itself. Extensive supplemental material is inappropriate. Oral history transcripts, correspondence between you and experts, questionnaires, and other primary or secondary material used as sources for your exhibit should be cited in your bibliography, but not included as attachments to your bibliography or exhibit.</i></p>
B3	<p><b>Media Devices</b></p>	<ul style="list-style-type: none"> <li>• Media devices (e.g., DVD players, tablets, mp3 players, video monitors, computers, etc.) used in an exhibit must not run for more than a total of three minutes.</li> <li>• Quotes from another source (e.g., clip from a documentary, primary source music, etc.) are considered quotes. Any student-composed questions, narration, or graphics incorporated within a media presentation are subject to the 500-word limit (Rule B2).</li> <li>• Viewers and judges must be able to control media devices. Any media devices must fit within the size limits of the exhibit.</li> <li>• Any media devices used should be integral to the exhibit—not a method to bypass the prohibition against live student involvement.</li> </ul>

B4	<b>Crediting Sources</b>	<ul style="list-style-type: none"> <li>• All quotes from written sources must be credited on the exhibit.</li> <li>• All visual sources (e.g., photographs, paintings, charts, and graphs, etc.) must be credited on the exhibit and fully cited in the annotated bibliography.</li> <li>• Brief, factual credits do not count toward the word total. See Figure 6 for an example of the difference between a credit and a caption.</li> </ul>
B5	<b>Required Written Materials</b>	<ul style="list-style-type: none"> <li>• Three copies of your title page, process paper, and bibliography should be presented to the judges for review. Be sure to bring an additional copy for your own reference. Refer to Part III, Rules 16-18, for citation and style information.</li> </ul>



**FIGURE 4 | EXHIBIT SIZE LIMIT ILLUSTRATION**

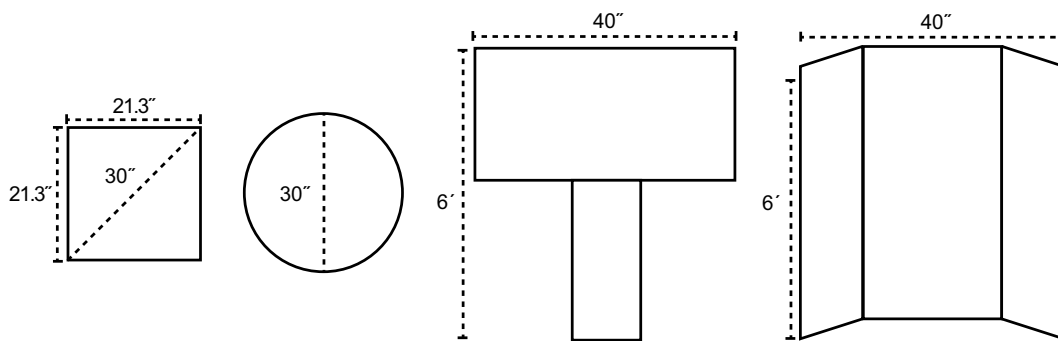

FIGURE 5 | COUNTING WORDS

Example from an exhibit board	Number of student-composed words	Explanation
John Quincy Adams served as the Secretary of State....	9	These are all student-composed words.
On August 18, 1920, the Nineteenth Amendment was ratified....	7	The date counts as one word.
When Thomas Jefferson wrote that “All men are created equal” in the Declaration of Independence...	10	Direct quotations from primary and secondary sources do not count as student-composed words.
“Four score and seven years ago, our fathers brought forth...” Abraham Lincoln, Gettysburg Address, November 19, 1863	0	Direct quotations from primary and secondary sources and brief, factual credits do not count as student-composed words.

FIGURE 6 | CREDITING VISUAL SOURCES



Alice Paul, 1918, Library of Congress

Alice Paul was responsible for the campaign for women’s suffrage and the introduction of the Equal Rights Amendment.

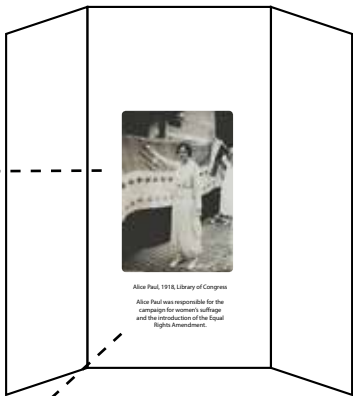

A brief, **FACTUAL CREDIT** is **REQUIRED** and does **NOT** count toward the 500-word limit.

A caption **DOES** count toward the 500-word limit.

## C. PERFORMANCE

A performance is a dramatic portrayal of your topic's significance in history and must be an original production. It should be scripted based on research of your chosen topic and should have dramatic appeal, but not at the expense of historical information.

**Part III, Rules for all Categories, applies to performances.**

C1	<b>Time Requirements</b>	<ul style="list-style-type: none"> <li>Performances may not exceed ten minutes in length. Timing starts at the beginning of the performance following the announcement of the title and student name(s).</li> <li>You will be allowed five minutes to set up and five minutes to remove any props needed for your performance.</li> </ul> <p><i><b>NOTE:</b> You should allow several empty seconds in your performance to account for unplanned pauses (e.g., applause, forgotten lines, etc.).</i></p>
C2	<b>Performance Introduction</b>	<ul style="list-style-type: none"> <li>The title of your entry and the names of the participants must be the first and only announcements prior to the start of the performance.</li> </ul>
C3	<b>Media Devices</b>	<ul style="list-style-type: none"> <li>Use of slides, mp3 players, computers, or other media within your performance is permitted. You must provide and run all equipment and carry out any special lighting or sound effects.</li> <li>Only those student(s) listed as entrants may participate in the production.</li> </ul>



C4	<b>Script</b>	<ul style="list-style-type: none"><li>The script for the performance should <b>not</b> be included with the written material presented to the judges.</li></ul>
C5	<b>Costumes</b>	<ul style="list-style-type: none"><li>You may have assistance in producing your costume, but the design, choice of fabrics, etc., must be your own. Or, you may rent a costume. Remember: simple is best.</li></ul>
C6	<b>Required Written Materials</b>	<ul style="list-style-type: none"><li>Three copies of your title page, process paper, and bibliography should be presented to the judges for review. Be sure to bring an additional copy for your own reference. Refer to Part III, Rules 16-18, for citation and style information.</li></ul>



## D. DOCUMENTARY

A documentary should reflect your ability to use audiovisual equipment to communicate your topic's significance. The documentary category will help you develop skills in using photographs, film, video, audio, computers, and graphic presentations. Your presentation should include primary source materials and also must be an original production. To produce a documentary, you must have access to equipment and be able to operate it.

**Part III, Rules for all Categories, applies to documentaries.**

D1	<p><b>Time Requirements</b></p>	<ul style="list-style-type: none"> <li>• Documentaries may not exceed ten minutes in length.</li> <li>• You will be allowed five minutes to set up and five minutes to remove equipment.</li> <li>• Timing begins when the first visual image appears and/or the first sound is heard. Audio and visual leads will be counted in the time limit.</li> <li>• Timing ends when the last visual image or sound of the presentation concludes (including credits).</li> </ul> <p><i><b>NOTE:</b> Use your setup time to prepare your documentary for presentation, adjust volume, etc.</i></p>
D2	<p><b>Introduction</b></p>	<ul style="list-style-type: none"> <li>• You must announce only the title of your presentation and names of participants.</li> <li>• Comments prior to or during the presentation, including live narration, are prohibited.</li> </ul>



D3	<b>Student Involvement and Operation</b>	<ul style="list-style-type: none"> <li>You must be able to run the program within the ten-minute time limit.</li> <li>You must provide and be able to run your own computers, software, and other equipment while presenting your documentary to the judges.</li> <li>Interactive computer programs and web pages in which the audience or judges are asked to participate are not acceptable; judges are not permitted to operate any equipment.</li> <li>Internet access may not be available.</li> </ul>
D4	<b>Student Production</b>	<ul style="list-style-type: none"> <li>All entries must be student-produced.</li> <li>You must operate all equipment, including all editing equipment used in the production of your presentation.</li> <li>You must provide the narration, voice-over, and dramatization. Only those student(s) listed as entrants may participate in the production.</li> <li>Only you/your group and the subjects of your interviews (participants in a historical event or experts) may appear on camera.</li> <li>Your entry must be an original production.</li> <li>Using material created by others specifically for use in your entry is prohibited.</li> </ul>
D5	<b>Entry Production</b>	<ul style="list-style-type: none"> <li>You may use professional photographs, film, recorded music, etc., within your presentation. However, you must give proper credit in the credits at the end of your presentation and in your annotated bibliography.</li> </ul> <p><i><b>NOTE:</b> Remember that different equipment may affect how your documentary appears on the screen. You should test equipment provided at competitions beforehand, bring back-up copies of your documentary in different formats, and/or bring your own equipment. There is no penalty for displaying your documentary on a laptop computer, and many students use them successfully as a backup measure.</i></p>
D6	<b>Credits</b>	<ul style="list-style-type: none"> <li>At the conclusion of the documentary, you must provide a list of acknowledgments and credits for ALL sources. These credits should be brief—not full bibliographic citations and not annotated.</li> <li>You are not required to credit individual images or video clips while the documentary is playing; that is the purpose of the credits at the end.</li> <li>All sources (e.g., music, images, film/media clips, interviews, books, websites, etc.) used in the making of the documentary must be properly cited in the annotated bibliography.</li> <li>The list of credits counts toward the ten-minute time limit and should be readable by viewers. See Figure 7 for an example.</li> </ul>
D7	<b>Required Written Materials</b>	<ul style="list-style-type: none"> <li>Three copies of your title page, process paper, and bibliography should be presented to the judges for review. Be sure to bring an additional copy for your own reference. Refer to Part III, Rules 16-18, for citation and style information.</li> </ul>





FIGURE 7 | EXAMPLE OF A CREDIT LIST FROM A DOCUMENTARY

### **Multimedia**

A Distant Shore: African Americans of D-Day

Saving Private Ryan

Images provided by The Library of Congress & The World War II Museum

Sound bites provided by The World War II Museum

Video clips provided by The Library of Congress & HISTORY®

### **Interviews**

Don Jackson

Martha Erickson

Charlotte Weiss

Jimmie Kanaya

## E. WEBSITE

The website category is the most interactive of all NHD categories. A website should reflect your ability to use website design software and computer technology to communicate your topic's significance in history. Your historical website should be a collection of web pages, interconnected by hyperlinks, that presents both primary and secondary sources and your historical analysis. To engage and inform viewers, your website should incorporate interactive multimedia, text, non-textual descriptions (e.g., photographs, maps, music, etc.), and interpretations of sources. To construct a website, you must have access to the Internet and be able to operate appropriate software and equipment.

### Part III, Rules for all Categories, applies to websites.

E1	<p style="text-align: center;"><b>Entry Production</b></p>	<ul style="list-style-type: none"> <li>• All entries must be original productions constructed using the NHD website editor, beginning at the school level: <a href="http://nhd.org/CategoryWebsite.htm">http://nhd.org/CategoryWebsite.htm</a></li> <li>• You may use professional photographs, graphics, video, recorded music, etc., within the site. Such items must be integrated into the website, and credit must be given within the site and cited in the annotated bibliography.</li> <li>• You must operate all software and equipment in the development of the website.</li> </ul> <p><i><b>NOTE:</b> Using objects or content created by others for specific use in your entry violates this rule. For example, adding viewer comments or using a graphic that others produced at your request is not permitted; however, using graphics, multimedia clips, etc., that already exist is acceptable.</i></p>
E2	<p style="text-align: center;"><b>Size Requirements</b></p>	<ul style="list-style-type: none"> <li>• Website entries may contain no more than 1,200 visible, student-composed words.</li> <li>• Code used to build the site and alternate text tags on images do not count toward the word limit.</li> <li>• Also excluded are words found in materials used for identifying illustrations or used to briefly credit the sources of illustrations and quotations; recurring menus, titles, and navigation instructions; required word count notifications; words within primary documents and artifacts; and the annotated bibliography and process paper, which must be integrated into the site. The process paper is limited to 500 words.</li> <li>• The entire site, including all multimedia, may use no more than 100MB of file space.</li> </ul>

E3	<b>Navigation</b>	<ul style="list-style-type: none"> <li>• One page of the website must serve as the home page. The home page must include the names of participants, entry title, division, number of student-composed words in the website, number of words in the process paper, and the main menu that directs viewers to the various sections of the site. See Figure 8 for an example.</li> <li>• All pages must be interconnected with hypertext links.</li> <li>• Automatic redirects are not permitted.</li> </ul>
E4	<b>Documents and Multimedia</b>	<ul style="list-style-type: none"> <li>• The website may contain documents (e.g., newspaper articles, excerpts from written text, etc.), but the documents must be contained within the website.</li> <li>• The website may contain multimedia clips (audio, video, or both) <b>that total no more than four minutes</b> (e.g., use one four-minute clip, four one-minute clips, two two-minute clips, etc.). Included in the four-minute total is any music or songs that play after a page loads.</li> <li>• You may record quotes and primary source materials for dramatic effect, but you may not narrate your own compositions or other explanatory material.</li> <li>• If you use any form of multimedia that requires a specific software to view (e.g., Flash, QuickTime, Real Player, etc.), you must provide on the same page a link to an Internet site where the software is available as a free, secure, and legal download.</li> <li>• You may not use embedded material or link to external websites, other than described in the preceding bullet.</li> <li>• Judges will make every effort to view all multimedia content, but files that cannot be viewed cannot be evaluated as part of the entry.</li> </ul>



E5	<b>Crediting Sources</b>	<ul style="list-style-type: none"> <li>• All quotes from written sources must be credited within the website.</li> <li>• All visual sources (photographs, videos, paintings, charts, and graphs) must be credited within the website. See Figure 9 for an example.</li> <li>• Brief, factual credits do not count toward the student-composed word total. See Figure 6 for an example.</li> <li>• All sources must be properly cited in the annotated bibliography.</li> </ul>
E6	<b>Required Written Materials</b>	<ul style="list-style-type: none"> <li>• The annotated bibliography and process paper must be included as an integrated part of the website. They should be included in the navigational structure. They do not count toward the 1,200-word limit. Refer to Part III, Rules 16-18, for citation and style information.</li> </ul>
E7	<b>Stable Content</b>	<ul style="list-style-type: none"> <li>• The content and appearance of a page cannot change when the page is refreshed in the browser. Random text or image generators are not allowed.</li> </ul>
E8	<b>Viewing Files</b>	<ul style="list-style-type: none"> <li>• The pages that comprise the site must be viewable in a recent version of a standard web browser (e.g., Microsoft Internet Explorer, Mozilla Firefox, Apple Safari, Google Chrome).</li> <li>• You are responsible for ensuring that your entry is viewable in multiple web browsers.</li> <li>• Entries may not link to live or external sites, except to direct viewers to software plug-ins, per Rule E4.</li> </ul>
E9	<b>Submitting Entries for Judging</b>	<ul style="list-style-type: none"> <li>• You must submit the URL for the site in advance by the established deadline, after which you will be blocked from editing your site to allow for judging.</li> <li>• Because all required written materials from Part III, Rule 13, are integrated into the site, NO printed copies are required.</li> <li>• For access to the NHD website editor and up-to-date submission procedures, please visit <a href="http://nhd.org/CategoryWebsite.htm">http://nhd.org/CategoryWebsite.htm</a>.</li> </ul>

FIGURE 8 | SAMPLE WEBSITE HOME PAGE



FIGURE 9 | SAMPLE WEBSITE PAGE WITH A VIDEO & PHOTOGRAPH PROPERLY CREDITED

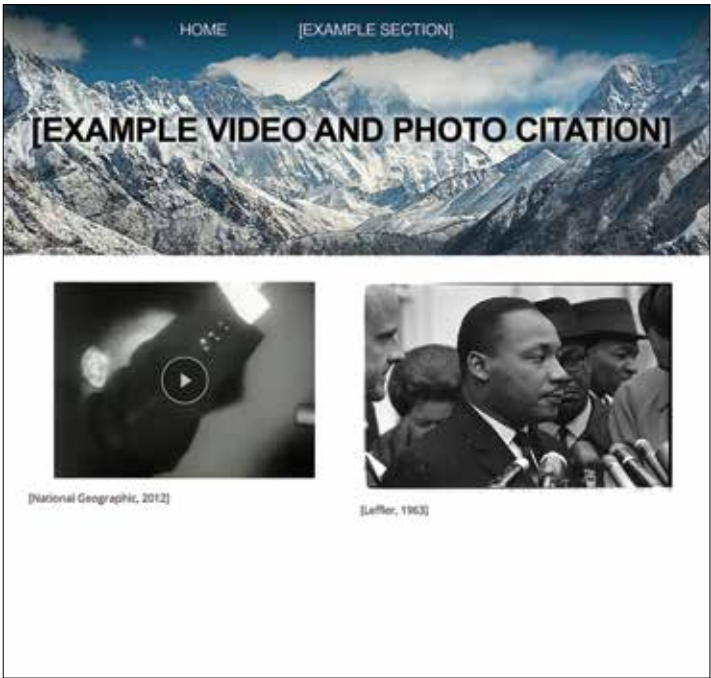

A. All visual sources must be credited within the website.

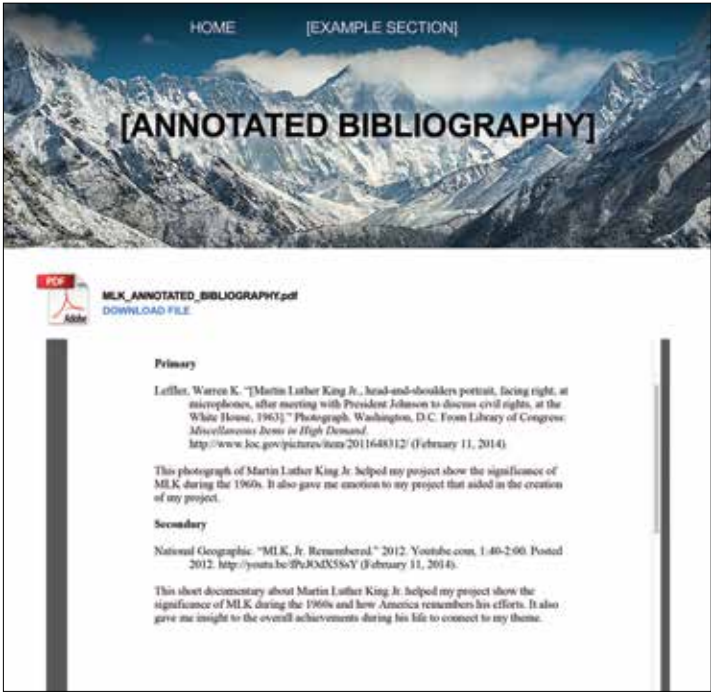

B. All sources must be properly cited in the annotated bibliography.



# How Will Your Entry Be Judged?

## BENEFITS OF THE EVALUATION PROCESS

NHD's goal is to provide you with a high-quality, educational experience—whether or not you win a prize. The judges' evaluations are part of the learning and skill-building process of NHD. The judges' evaluations help you to improve skills and provide positive feedback for the hard work you have put into producing your project. The judges' comments also can provide you with ideas for revisions and enhancements as you move from one contest level to the next. Remember, regardless of how your entry is ranked, by participating in NHD you will benefit from the experience. You will gain research, thinking, and presentation skills that will last your entire life. You will become an expert on a topic of interest to you and to others. You will learn to manage your time and acquire poise and self-confidence.

## WHO ARE THE JUDGES?

Historians, educators, and others interested in history and education serve as judges at each level of the NHD competition. Contest coordinators work very hard to ensure a quality judging experience.

## HOW DOES THE EVALUATION PROCESS WORK?

At official NHD contests, each division and category (e.g., Junior Group Exhibit, Senior Paper, etc.) usually is judged as a whole by a panel of judges. Time constraints due to the number of entries often require entries in some categories to be divided among several teams of judges. Finals then become necessary. In such cases, the entries judged best by each team of initial judges are re-evaluated by a new team of judges to determine the winning entries in the category. The number of entries in finals and procedures for judging vary by contest and category and are within the discretion of the contest officials.



### CONSENSUS JUDGING

Judges will not assign a numerical score to each entry; rather, they will rank the entries in their group. Judges are required to consult with each other in determining individual rankings. Judges are encouraged to review the results of their category to assure accuracy in the evaluation process.

### THE SUBJECTIVE NATURE OF JUDGING

Judges must evaluate certain aspects of your entry that are objective (e.g., were primary sources used; is the written material grammatically correct and accurately spelled, etc.). But judges also must evaluate interpretive aspects of your entry that are qualitative in nature (e.g., analysis and conclusions about the historical data, etc.). Historians often reach different opinions about the significance of the same data. It is therefore crucial for you to base your interpretations and conclusions on solid research. Judges will check to determine whether you used available primary sources and whether you were careful to examine all sides of an issue and present a balanced account of your research and presentation. Your process paper and annotated bibliography are critical to this process.

### THE DECISION OF THE JUDGES IS FINAL

You, your parents, and your teachers should realize that inadvertent inequities may occur in judging and that contest officials do want to be informed of any problems. If you have a concern, ask your teacher about the correct process to follow in notifying officials. The decision of the judges is final.



## EVALUATION CRITERIA

### Historical Quality (60%)

The most important aspect of your entry is its historical quality. You should ask yourself the following questions to help you focus on your historical analysis.

- Is my entry historically accurate?
- Does my entry provide analysis and interpretation of the historical data rather than just a description?
- Does my entry demonstrate an understanding of historical context?
- Does my annotated bibliography demonstrate wide research?
- Does my entry demonstrate a balanced presentation of materials?
- Does my entry demonstrate use of available primary sources?

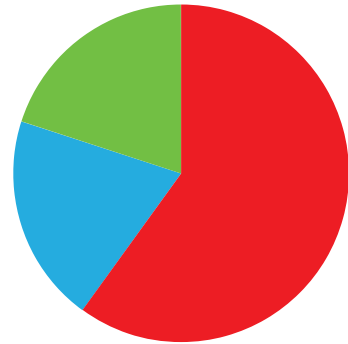

Historical Quality (60%)  
Relation to Theme (20%)  
Clarity of Presentation (20%)

### Relation to Theme (20%)

Your entry must explain clearly the relation of your topic to the annual NHD theme. You should ask yourself the following questions to help focus your topic on the theme and its significance.

- How does my topic relate to the theme?
- Why is my topic important?
- How is my topic significant in history and in relation to the NHD theme?
- How did my topic influence history?
- How did the events and atmosphere (social, economic, political, and cultural aspects of my topic's time period) influence my topic in history?

### Clarity of Presentation (20%)

Although historical quality is most important, your entry must be presented in an effective manner. You should ask yourself the following questions to help you focus on your presentation.

- Is my entry original, creative, and imaginative in subject and presentation?
- Is my written material clear, grammatically correct, and accurately spelled?
- Is my entry well-organized?
- Do I display stage presence in a performance?
- Is my visual material presented clearly?

### RULE COMPLIANCE

**Rule infractions** occur when you violate any of the rules stated in this *Contest Rule Book*. Infractions are not grounds for disqualification, but judges will take any rule infractions into consideration in their final rankings. Failure to comply with the rules will count against your entry. Any rule infractions should be corrected before a winning entry competes in the next level of competition.

A project may be **disqualified** from the contest on three grounds:

1. Plagiarizing all or part of the NHD project. Please note that failing to give proper credit is plagiarism.
2. Reusing, individually or as a group, a project (or research from a project from a previous year, or entering a project in multiple contests or entry categories within a contest year).
3. Tampering with any part of the project of another student.



## SAMPLE JUDGES' EVALUATIONS

Below are sample NHD project evaluation forms. You and your teacher can use these forms to help evaluate your project as you work to improve your entry. Blank forms can be found on the NHD website at <http://www.nhd.org/NHDintheCurriculum.htm>.

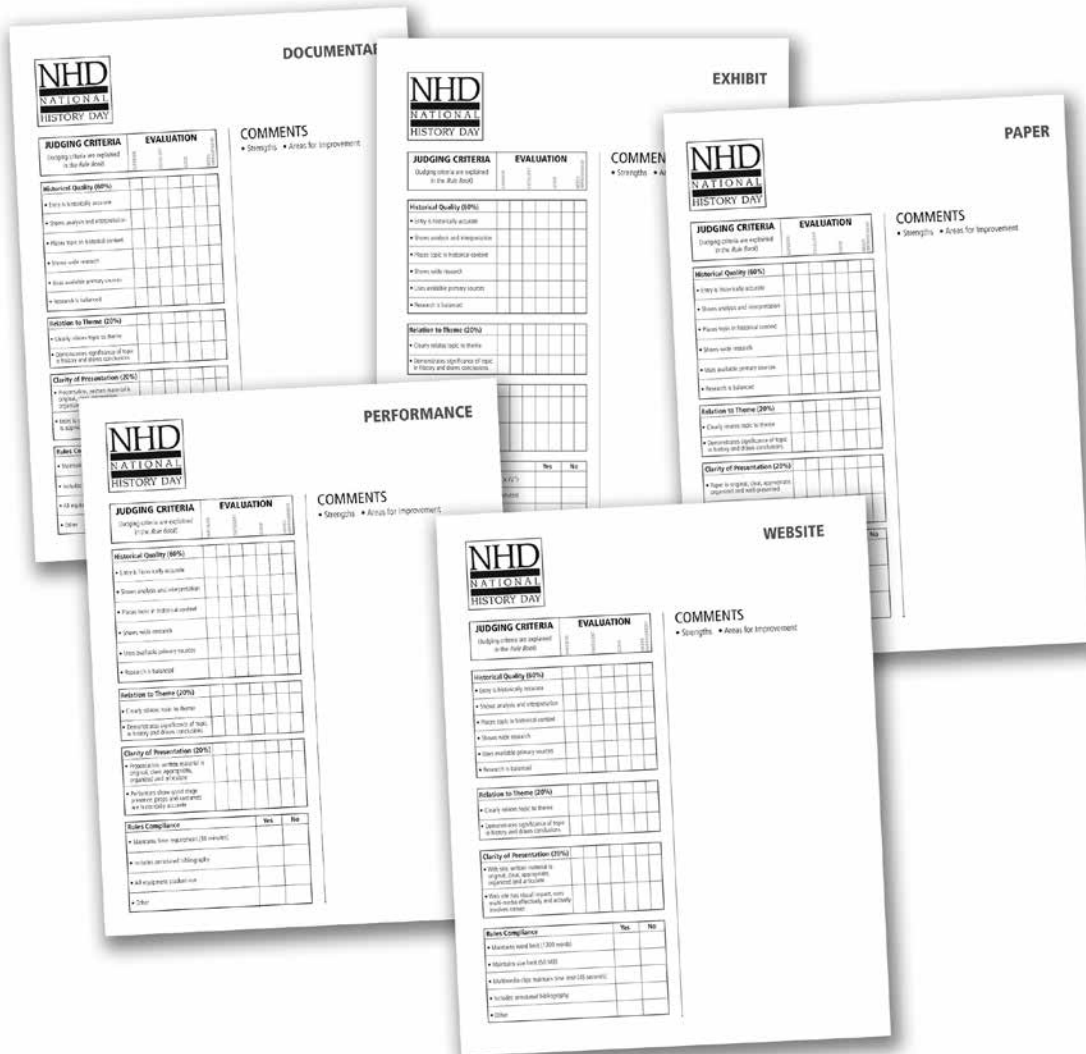





# VI. Rules Verification Sheets

Rules Verification Sheets are designed to help you and your teacher verify that you have met both the rules for all entries and the rules for your category. These sheets are not required for the contest. Blank sheets can be downloaded on the NHD website at <http://www.nhd.org/NHDintheCurriculum.htm>.



# For Further Information

---

## Contact

National History Day  
4511 Knox Road, Suite 205  
College Park, MD 20740

Telephone: (301) 314-9739  
E-mail: [info@nhd.org](mailto:info@nhd.org)  
Web: <http://www.nhd.org>

Copyright ©2014 National History Day, Inc.

May be duplicated without permission of National History Day; duplication for profit is prohibited.

For more information about NHD and answers to frequently asked questions about rules and procedures, check out the NHD website at <http://www.nhd.org>.

## Acknowledgments

NHD is grateful to John Krueckeberg, Co-coordinator of the New Hampshire affiliate, and to members of the Executive Council of Coordinators, for their careful editing of the *Contest Rule Book*.

# NHD Wishes to Thank its Major Sponsors

---

Kenneth E. Behring

Patricia Behring

The WEM 2000 Foundation  
of the Dorsey and Whitney Foundation

Albert H. Small



WEIDER HISTORY GROUP



Proud to be the Official Airline  
of National History Day